

Instruction Manual

BGR-01

OPTEX *Ricochet* wireless transmitter

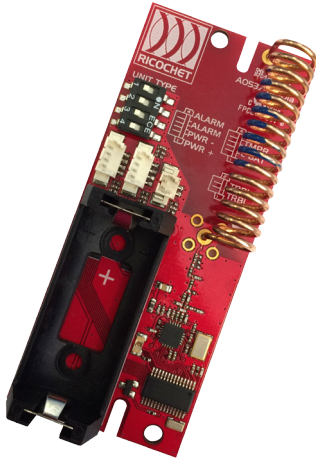

Introduction

- For wireless connectivity, detailed programming and system set-up instructions please refer to the compatible RICOCHET™ technology enabled Premier Elite wireless expander instructions.
- Featuring RICOCHET™ wireless technology, the BGR-01 is designed for Optex battery powered devices for professional security installations.
- When using the BGR-01 on an Entry/Exit route, or where chime is required, the device attributes should be set to “Always Awake”.
- Please see the Premier Elite 8XP-W/32XP-W Installation Manual for details of how to change the device attributes
- For wiring and installation instructions refer to OPTEX device manual. The supplied wiring loom may not be required for some OPTEX devices, in this case use (the supplied) device wiring loom.
- Active Beams can use either one or two Ricochet BGR-01

Note:

For use with Telexcom Premier Elite with Ver 3.01 firmware or higher.

Connection

1. Configure Dip Switch setting to match the Optex sensor
2. Connect Optex sensor directly using 4way and/or 2way plug (VXI, FTN, RXC-RST). For HX, BX and Active Beams use the supplied cables
3. Install the CR123A battery to learn the device on to the system

Battery

Only replace with 3V Lithium CR123A

Battery Safety

- Do not throw into a fire
- Do not heat
- Do not charge
- Do not short circuit
- Do not disassemble
- Replace only with same or equivalent type
- Always observe local regulations when disposing of a battery
- Detector will transmit low battery warning when battery needs replacing

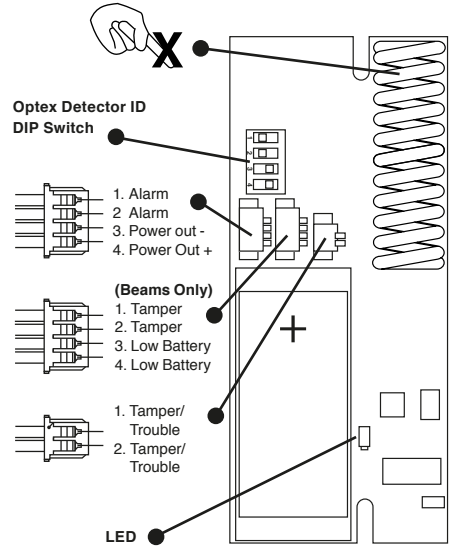

Instruction Manual

BGR-01

OPTEX *Ricochet* wireless transmitter

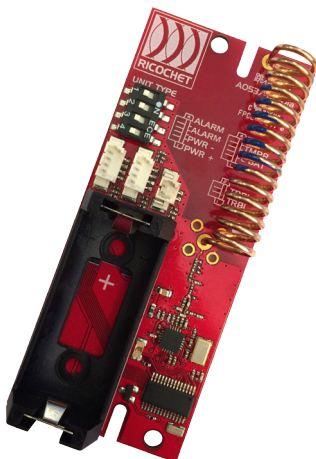

Introduction

- For wireless connectivity, detailed programming and system set-up instructions please refer to the compatible RICOCHET™ technology enabled Premier Elite wireless expander instructions.
- Featuring RICOCHET™ wireless technology, the BGR-01 is designed for Optex battery powered devices for professional security installations.
- When using the BGR-01 on an Entry/Exit route, or where chime is required, the device attributes should be set to “Always Awake”.
- Please see the Premier Elite 8XP-W/32XP-W Installation Manual for details of how to change the device attributes
- For wiring and installation instructions refer to OPTEX device manual. The supplied wiring loom may not be required for some OPTEX devices, in this case use (the supplied) device wiring loom.
- Active Beams can use either one or two Ricochet BGR-01

Note:

For use with Telexcom Premier Elite with Ver 3.01 firmware or higher.

Connection

1. Configure Dip Switch setting to match the Optex sensor
2. Connect Optex sensor directly using 4way and/or 2way plug (VXI, FTN, RXC-RST). For HX, BX and Active Beams use the supplied cables
3. Install the CR123A battery to learn the device on to the system

Battery







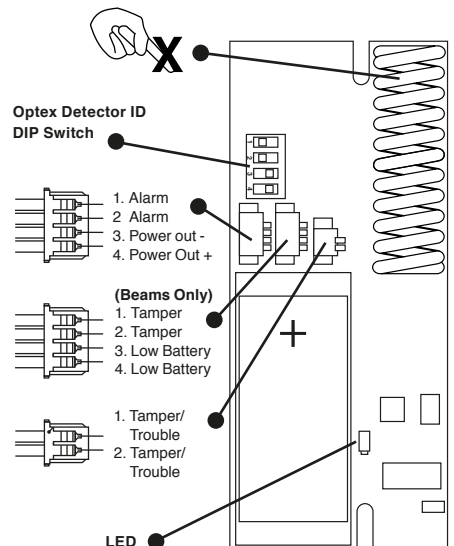

Only replace with 3V Lithium CR123A

Battery Safety

- Do not throw into a fire
- Do not heat
- Do not charge
- Do not short circuit
- Do not disassemble
- Replace only with same or equivalent type
- Always observe local regulations when disposing of a battery
- Detector will transmit low battery warning when battery needs replacing



DIP switch settings

OPTEX Detector ID	DIP Setting
SL-350-QxR Receiver	 1
SL-350-QxR Transmitter	 2
AX-x00-TFR Receiver	 3
AX-x00-TFR Transmitter	 4
BX-80xR	 5
HX-xxR	 6
FTN-Rx	 7
VXI-Rx	 8
RXC-RST	 9

LED status indication

Solid	On power-up, while learning to network
Rapid Flash	On learn fail, attempting to connect to learnt network
Blinks every 0.5s	Tamper or Trouble inputs are open.
Slow Flash 0.5s	Tamper or trouble has transitioned from open to close
Solid for 3s	Communication successful

Connection Tables

VXI-Rx FTN-Rx RXC-RST BX-80xR HX-xxR

1. Yellow	Alarm in
2. White	Alarm In
3. Black	Power -ve out
4. Red	Power +ve out
1. Blue	Tamper/Trouble
2. Green	Tamper/Trouble
Active Beams SL and AX (use supplied cables)	
1. Yellow	(Rx) Alarm in
2. White	(Rx) Alarm In
3. Black	Not used
4. Red	Not used
1. Orange	(Tx&Rx) Tamper
2. Brown	(Tx&Rx) Tamper
3. Purple	(Tx&Rx) Low Battery
4. Grey	(Tx&Rx) Low Battery
1. Blue	(Rx) DQ
2. Green	(Rx) DQ

Specification

EMC:	EN50130-4:2014:A1:A2 ETSI EN301 489-03 V1.6.1:2013
RADIO	ETSI EN300-220(V2.4.1)
Frequency Band:	868.0 – 868.6 MHz
Product type:	BGR-001 868MHz
Receiver:	Category 1, Class 2
Receiver LBT	(Listen Before Talk) Yes
Transmitter Duty Cycle	868MHz<1%
Low Voltage Signal	2.85v
Operating Voltage	3v
Maximum current	32mA
Quiescent current	60uA







Warranty

2 year replacement warranty (excludes battery).

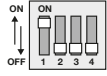
The BGR-01 is designed to be used with OPTEX battery powered detection devices and activate an alarm control panel. As the BGR-01 is not a complete alarm system, but only part thereof, Optex cannot accept responsibility or liability for any damages whatsoever based on a claim that the BGR-01 failed to function correctly.

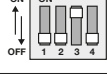
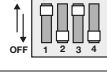

DIP switch settings

OPTEX Detector ID	DIP Setting
SL-350-QxR Receiver	 1
SL-350-QxR Transmitter	 2
AX-x00-TFR Receiver	 3
AX-x00-TFR Transmitter	 4
BX-80xR	 5
HX-xxR	 6
FTN-Rx	 7
VXI-Rx	 8
RXC-RST	 9

LED status indication

Solid	On power-up, while learning to network
Rapid Flash	On learn fail, attempting to connect to learnt network
Blinks every 0.5s	Tamper or Trouble inputs are open.
Slow Flash 0.5s	Tamper or trouble has transitioned from open to close
Solid for 3s	Communication successful

Connection Tables

VXI-Rx FTN-Rx RXC-RST BX-80xR HX-xxR

1. Yellow	Alarm in
2. White	Alarm In
3. Black	Power -ve out
4. Red	Power +ve out
1. Blue	Tamper/Trouble
2. Green	Tamper/Trouble
Active Beams SL and AX (use supplied cables)	
1. Yellow	(Rx) Alarm in
2. White	(Rx) Alarm In
3. Black	Not used
4. Red	Not used
1. Orange	(Tx&Rx) Tamper
2. Brown	(Tx&Rx) Tamper
3. Purple	(Tx&Rx) Low Battery
4. Grey	(Tx&Rx) Low Battery
1. Blue	(Rx) DQ
2. Green	(Rx) DQ

Specification

EMC:	EN50130-4:2014:A1:A2 ETSI EN301 489-03 V1.6.1:2013
RADIO	ETSI EN300-220(V2.4.1)
Frequency Band:	868.0 – 868.6 MHz
Product type:	BGR-001 868MHz
Receiver:	Category 1, Class 2
Receiver LBT	(Listen Before Talk) Yes
Transmitter Duty Cycle	868MHz<1%
Low Voltage Signal	2.85v
Operating Voltage	3v
Maximum current	32mA
Quiescent current	60uA

Warranty

2 year replacement warranty (excludes battery).

The BGR-01 is designed to be used with OPTEX battery powered detection devices and activate an alarm control panel. As the BGR-01 is not a complete alarm system, but only part thereof, Optex cannot accept responsibility or liability for any damages whatsoever based on a claim that the BGR-01 failed to function correctly.

